

BORDILLOS

COMERCIAL CEYFOR S.L.
 CAMINO SANTA INES, s/n.
 Apartado de Correos, 14
 29.590 CAMPANILLAS (Málaga)
 Telfs.: 95 / 243 30 00 - 243 30 01 - 262 52 10
 Fax: 95 / 262 53 41
 E-mail: comercial@ceyfor.es
 Web: www.ceyfor.es

TIPO DE PIEZA Denominación	DIMENSIONES	UNIDAD METRO	PESO KGS. APROX.
A1	100 x 14/11 x 20	1	62,70
A2	50 x 10/9 x 20	2	23,00
C3	50 x 17/14 x 28	2	53,00
C4	50 x 15/12 x 28	2	47,50
C5	50 x 15/12 x 25	2	41,20
C6	50 x 15/9 x 25	2	33,20
C7	50 x 12/9 x 25	2	44,00
R4 - RIGOLA	50 x 30 x 13	2	43,00
BJ6	50 x 06 x 20	2	13,40
BJ10	50 x 10 x 20	2	23,40
BJC BOTA	50 x 40 x 25	2	56,00

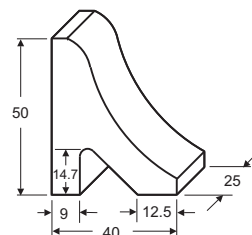
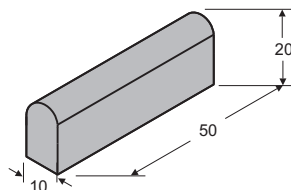
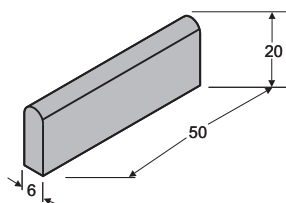
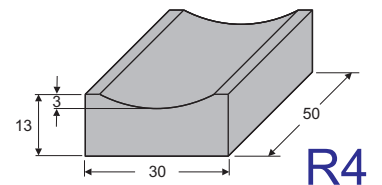
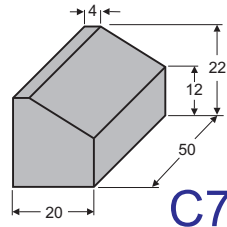
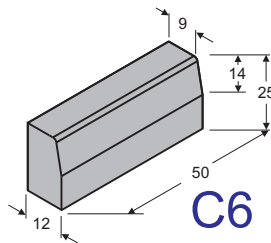
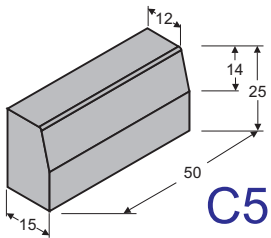
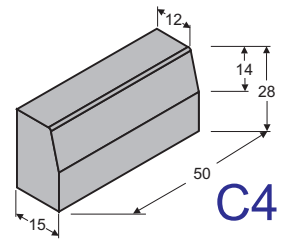
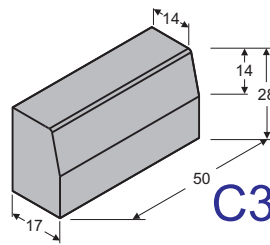
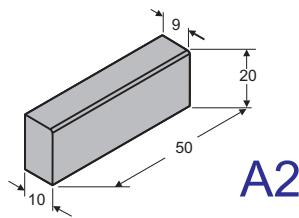
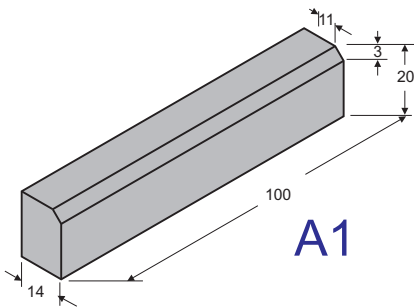

Inscrita en el Registro Mercantil de Málaga, tomo 1.085, libro nº 2, folio 190, hoja nº MA-648, inscripción 1ª el 6-7-90. C.I.F. - B - 29.421.716